



MATERIA --- COLLECTION

LUXURY DECOR & BESPOKE SOLUTIONS

DRAPE LOUNGE - Drape Collection

LAURAMERONI
design . collection



Swivel armchair covered with leather or velvet and with memory foam seat.

Designed by Bartoli Design, it offers an extremely comfortable seat for luxury environments. The high quality of leather combines with a sophisticated design, creating a unique product.

This armchair can be covered with leather or velvet to adapt to different environments and to create infinite combinations.

The lacquered metal base gently supports the soft curved lines of the armchair.





Drapé Lounge is a comfortable swivel armchair with memory foam seat characterized by soft lines.

This armchair can be covered with leather or velvet to adapt to different environments and to create infinite combinations.

Drapé Lounge can be used in private or public spaces to offer a comfortable seat in waiting areas.

The special tailoring work turns each single armchair into a unique and unrepeatable piece.

DIMENSIONS

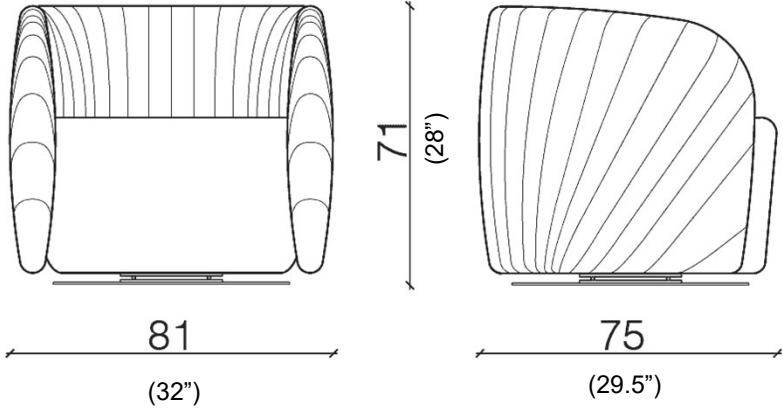

VELVETS



407



417



403

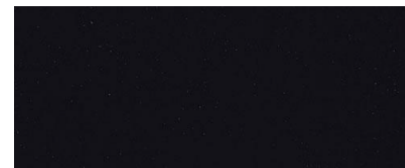

406



412



438



418



415



405



401



431



487

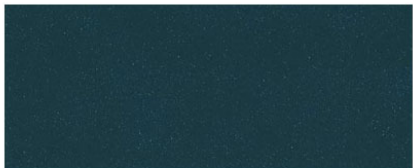

429



409



404



414



413



424

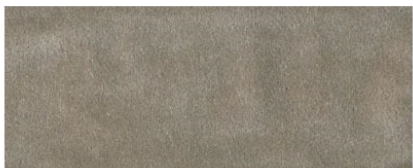

437



457

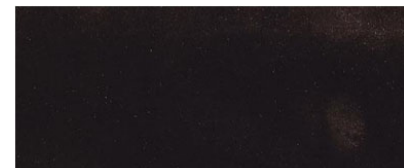

477

SKIN LEATHERS



Skin Ebony



Skin Garnet



Skin Marble



Skin Mud



Skin Night

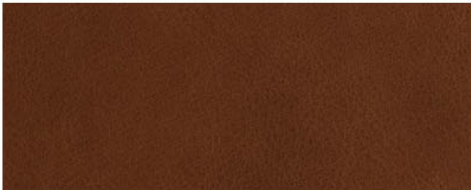

Skin Rust

SWING LEATHERS

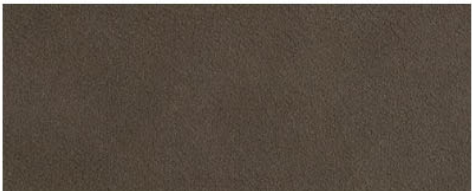

Swing 4507

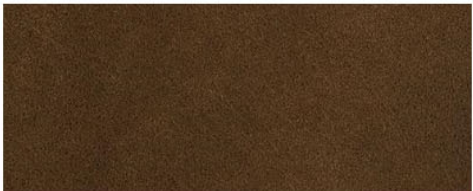

Swing 4501



Swing 4502



Swing 4503



Swing 4504

NUBUCK LEATHERS



Nubuck 2118



Nubuck 2133

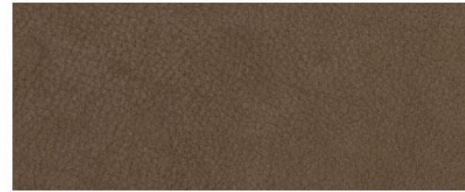

Nubuck 2132

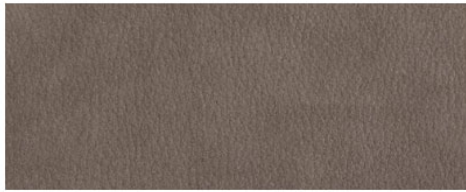

Nubuck 2115



Nubuck 2105



Nubuck 2103



Nubuck 2102



Nubuck 2101



Nubuck 2100

PIXEL LEATHERS



Pixel Antracite



Pixel Guacamole



Pixel Vino



Pixel Nocciola

TOSCA LEATHERS

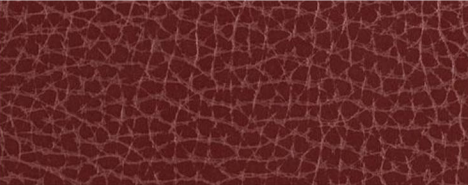

Tosca Bordeaux



Tosca Cognac



Tosca Marrone



Tosca Testa di Moro

MATERIA

COLLECTION
LUXURY DECOR AND BESPOKE SOLUTIONS

1060 Kane Concourse, Bay Harbor Islands, FL 33154

www.materiacollection.com | info@materiacollection.com

1-800-849-4953 | 786-438-1330

LAURAMERONI
design . collection

U.S.A HEADQUARTERS